

## Life Science

- Cell Culture Series / PCR Supplies -



- Sterile Syringe filters
- Bottle Top Filters
- Cell Culture Dishes
- Cell Culture Plates
- Cell Culture Flasks
- Sterile Centrifuge Tubes
- Pipette Filter Tips
- Sterile Serological Pipette
- PCR Tubes
- PCR 96 well Plates



Sterile Syringe Filters



Racked Filter Tips



Cell Culture Plates



Bottle Top Filters



**NEW !!**  
Serological Pipette



PCR Supplies



Cell Culture Flasks



Cell Culture Dishes

VISIT US

 [www.finetech-filters.com](http://www.finetech-filters.com)

# ABOUT US

## Constantly researching and innovating...

Finetech Research and Innovation Corporation was established in 1999 and has been engaged in the gas and fluid filtration used in laboratories and the medical fields for many years. We concentrate on the researching, developing, and manufacturing of lab filters such as syringe filters, 50mm air/vent filters, pipette filters, gas analyzer filters, and customized filters.

In 2004, we were the first manufacturer of transducer protectors used in dialysis. In 2017, sales of transducer protectors had reached to over 30 million pieces/year. Our high quality and ISO 13485 certified transducer protectors has kept our customers satisfied for more than 14 years.

Manufactured in 2010, our syringe filter is designed to provide efficient filtration of aqueous and organic solutions. It can be used to remove particles from a sample prior to analysis by HPLC, for the filtration of gases, and for the removal of bacteria from a sample. Syringe filters are widely used in environmental, pharmaceutical, biotechnology, and agricultural testing laboratories.

In 2015, Finetech designed and manufactured caps, septa, and samples vials used in chromatography. We supply HPLC consumables to the global chromatography community in over 36 countries. We constantly innovate with releases of new lab consumables and medical devices every year. Some of the other products we manufacture are sterile syringe filter, membrane filters, centrifuge tube, glass microfiber filters, vacuum filtration system, and QuECh-ERS. To find out more, please visit our website "[www.finetech-filters.com](http://www.finetech-filters.com)".

## History

- 2021 Developed Racked Filters Tips, PCR Supplies, Cell Culture Series
- 2020 Produced Disposable Medical Masks
- 2019 Produced Bottle Top Filter Unit
- 2018 Researched and developed QuEChERS
- 2017 Produced 15mL & 50mL centrifuge tubes (sterile & non-sterile)
- 2016 New product launched – sterile filtration cup
- 2015 Achieved ISO 9001. Received award of Conventional Industry Technology Development for Medical grade septa
- 2014 Started producing sterile syringe filters
- 2012 Produced the 1st 50mm air vent filters
- 2010 Produced the 1st syringe filters manufactured in a cleanroom
- 2008 Developed transducer protectors. 1st manufacturer in Asia
- 2005 Awarded the Medical Device award from Taiwan Government
- 1999 Finetech Research and Innovation Corporation established



Taiwan Factory



China Office



Vietnam Factory

# Product Timeline



**1999**

Finetech Research and Innovation Corporation established.



**2008**

Developed autoclavable transducer protector.



**2012**

Produced the first 50mm air/vent filters in Taiwan.



**2015**

Started production of vials for chromatography and environmental analysis.

**2016**

New product launched – sterile filtration cup.



**2018**

Researched and developed QuEChERS kit



**2020**

Disposable Medical Masks



**2004**

Developed transducer protectors. Was the first manufacturer in Asia.



**2010**

Produced the first syringe filters manufactured in a cleanroom in Taiwan.(PureTech)



**2014**

Started producing sterile syringe filters.



**2015**

Vacuum Pump & Vacuum Filtration System (Stainless Steel manifold)



**2017**

Produced 15mL & 50mL centrifuge tubes (sterile & non-sterile)

**2019**

Bottle Top Filter Unit  
100ml Funnel Filter



**2021**

Rack Filter Tips & PCR Supplies  
Cell Culture Series  
Petri Dish

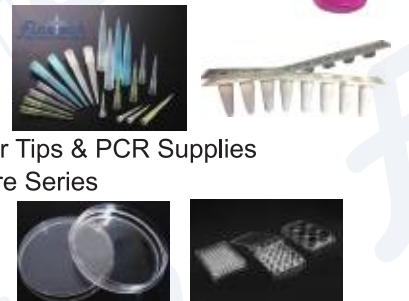

# Contents

<b>A. Finetech<sup>®</sup> Sterile Syringe filters</b>	.....04
<b>B. Finetech<sup>®</sup> Bottle Top Filters</b>	.....05
<b>C. Finetech<sup>®</sup> Cell Culture Plates</b>	.....06
<b>D. Finetech<sup>®</sup> Cell Culture Flasks</b>	.....07
<b>E. Finetech<sup>®</sup> Cell Culture Dishes</b>	.....08
<b>F. Finetech<sup>®</sup> Erlenmeyer Shake Flasks</b>	.....09
<b>G. Finetech<sup>®</sup> Centrifuge Tubes</b>	.....10
<b>H. Finetech<sup>®</sup> Pipette Filter Tips</b>	.....12
<b>I. Finetech<sup>®</sup> Sterile Serological Pipette</b>	.....14
<b>J. Finetech<sup>®</sup> Cryotubes</b>	.....16
<b>K. Finetech<sup>®</sup> PCR Supplies</b>	
<b>K1. PCR Single Tubes</b>	.....17
<b>K2. PCR 8-Strip Tubes</b>	.....18
<b>K3. PCR 96 Well Plates</b>	.....20
<b>L. Finetech<sup>®</sup> Nasal Swab</b>	.....22

# A. Finetech® Sterile Syringe filters



**13mm**

- Housing material: Medical grade polypropylene
- Pore Size: 0.22µm, 0.45µm
- Outside diameter: 17mm
- Membrane diameter: 13mm
- High flow rate and throughput
- Low hold-up volume (less than 25µL)
- Low extractables
- Individual sterile blister pack



**33mm**

- Housing material: Medical grade polypropylene
- Pore Size: 0.22µm, 0.45µm
- Outside diameter: 33mm
- Membrane diameter: 25mm
- High flow rate and throughput
- Low hold-up volume (less than 100µL)
- Low extractables
- Individual sterile blister pack

## ❖ Ordering Information

① Membrane		② Diameter	③ Sterile	④ Pore size	⑤ Membrane characteristics
PVDF PTFE Nylon MCE	CA PES RC GF	017=13mm 033=33mm	N (Non-Sterile) S (EO/GAMMA)	022=0.22µm 045=0.45µm	I = hydrophilic O = hydrophobic
13mm: 100pcs/pk    33mm: 100pcs/pk					
<b>Example: <u>PVDF</u> <u>033</u> <u>S</u> <u>022</u> <u>I</u> = 33mm, PVDF membrane, Sterile, 0.22µm</b>					
		①	②	③	④ ⑤

# B. Finetech<sup>®</sup> Bottle Top Filters

## ❖ Features

- Manufactured from virgin Polystyrene.
- Tissue culture treated surface to aid in cell attachment.
- Walls have even thickness and no distortion.
- Wide design increases stability when stacked.
- Quick opening cap.
- Angled bottleneck, convenient for pipettes and cell scraping.
- Frosted write-on spot.
- Clear graduation scale.

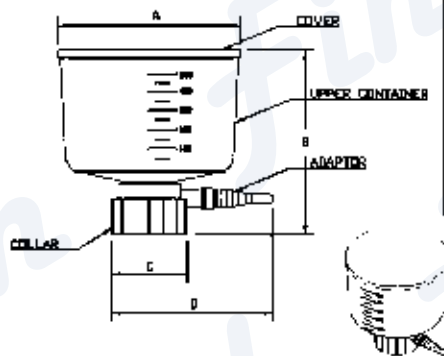
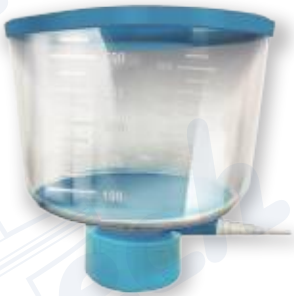

PORE SIZE(um)	0.22	
UPPER CAP(um)	500	
BOTTLE NECK SIZE	45mm	
MEMBRANE COLOR	WHITE	
MEMBRANE DIA(mm)	90	
	INCHES	MM
A	4.45	113
B	4.19	114
C	1.806	47.9
D	3.937	100
NDM.WT.(gms)	75	

MATERIALS	
COVER	BLUE LOPE
UPPER CONTAINER	PS
ADAPTOR	WHITE ABS
COLLAR	BLUE PE

## ❖ Ordering Information

	Membrane	Diameter	Pore Size	Description	Packaging
<b>FC-PVDF500G022I-90</b>	PVDF	90mm	0.22um	Sterile Bottle Top Vacuum Filter Funnel Capacity: 500ml Individually Packed	12pcs/CTN
<b>FC-PVDF500G045I-90</b>	PVDF	90mm	0.45um	Sterile Bottle Top Vacuum Filter Funnel Capacity: 500ml Individually Packed	12pcs/CTN
<b>FC-PES500G022I-90</b>	PES	90mm	0.45um	Sterile Bottle Top Vacuum Filter Funnel Capacity: 500ml Individually Packed	12pcs/CTN
<b>FC-PES500G045I-90</b>	PES	90mm	0.45um	Sterile Bottle Top Vacuum Filter Funnel Capacity: 500ml Individually Packed	12pcs/CTN

# C. Finetech<sup>®</sup> Cell Culture Plates

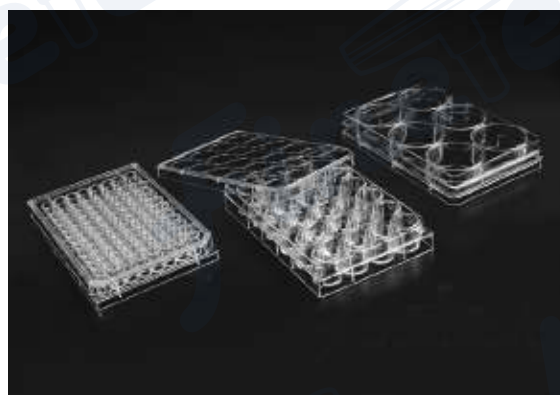
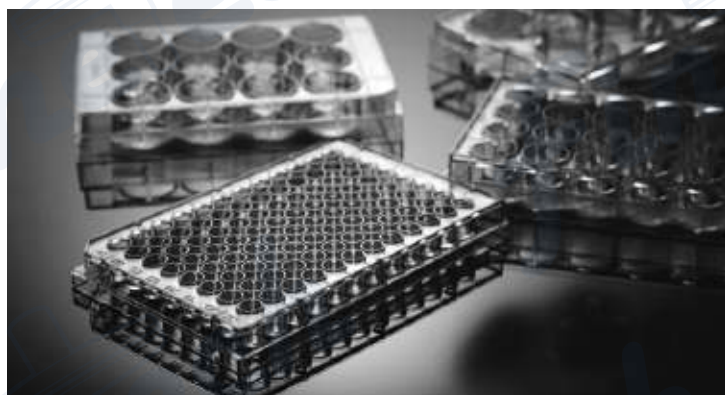

## ❖ Features

- Available in 6, 12, 24, 48, 96 well plates.
- Manufactured from virgin Polystyrene.
- Tissue culture treated surface to aid in cell attachment.
- Tight fitting cover prevents contamination and loss by evaporation.
- One-way cover reduces errors.
- Alphanumeric labels for easy organization.
- Stack-able to save space.
- E-Beam sterilization.
- DNase/RNase-free and non-pyrogenic.

## ❖ Ordering Information

Model No.	Number of Wells	Bottom	Cell Growth Area	Recommended Volume	Sterile	Packaging
CCWP6-S	6	Flat	9.5 cm <sup>2</sup>	1.9-2.9 mL	Yes	50pcs/carton
CCWP12-S	12	Flat	3.6 cm <sup>2</sup>	0.76-1.14 mL	Yes	50pcs/carton
CCWP24-S	24	Flat	1.9 cm <sup>2</sup>	0.38-0.57 mL	Yes	50pcs/carton
CCWP48-S	48	Flat	0.88 cm <sup>2</sup>	0.19-0.285 mL	Yes	50pcs/carton
CCWP96-S	96	Flat	0.32 cm <sup>2</sup>	0.1-0.2 mL	Yes	65pcs/carton

# D. Finetech® Cell Culture Flasks

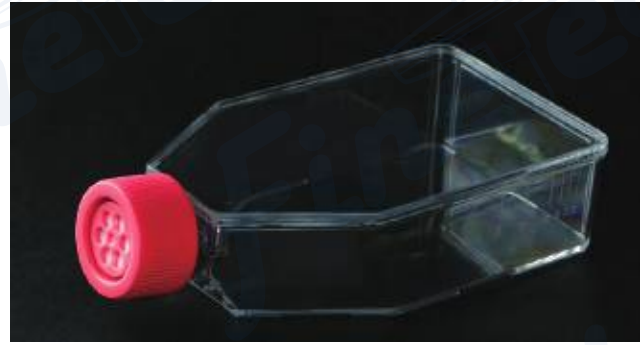

## ❖ Features

- Manufactured from virgin Polystyrene.
- Tissue culture treated surface to aid in cell attachment.
- Walls have even thickness and no distortion.
- Wide design increases stability when stacked.
- Quick opening cap.
- Angled bottleneck, convenient for pipettes and cell scraping.
- Frosted write-on spot.
- Clear graduation scale.
- Stack-able to save space.
- E-Beam sterilization.

## ❖ Ordering Information

Model No.	Volume	Recommended Volume	Cell Growth Area	Cap	Sterile	Packaging
CCF25SC-S	50 mL	5-7.5 mL	25 cm <sup>2</sup>	Sealed	Yes	12/pack 300/case
CCF75SC-S	250 mL	15-22.5 mL	75 cm <sup>2</sup>	Sealed	Yes	5/pack 90/case
CCF175SC-S	750 mL	35-52.5 mL	175 cm <sup>2</sup>	Sealed	Yes	5/pack 50/case
CCF25FC-S	50 mL	5-7.5 mL	25 cm <sup>2</sup>	Vent	Yes	12/pack 300/case
CCF75FC-S	250 mL	15-22.5 mL	75 cm <sup>2</sup>	Vent	Yes	5/pack 90/case
CCF175FC-S	750 mL	35-52.5 mL	175 cm <sup>2</sup>	Vent	Yes	5/pack 50/case



## E. Finetech<sup>®</sup> Cell Culture Dishes

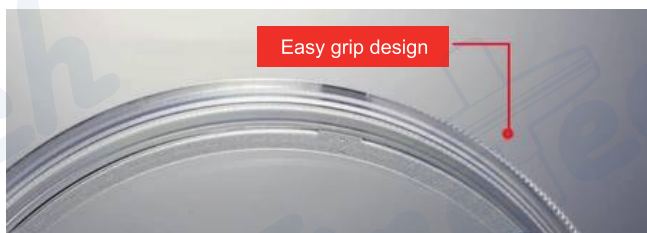
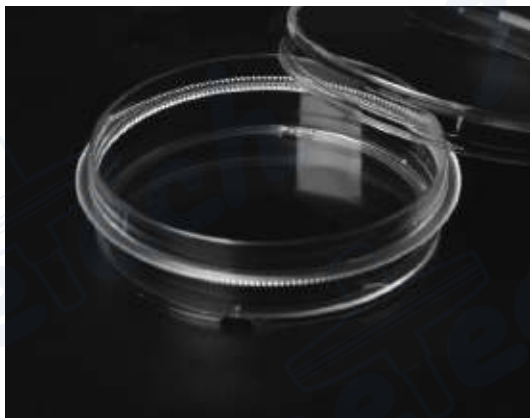

### ❖ Features

- Tissue culture treated surface to aid in cell attachment.
- Flat and with even thickness. Allowing distortion-free observation.
- Easy to grip sides.
- E-Beam sterilization.
- DNase/RNase-free and non-pyrogenic.

### ❖ Ordering Information

Model No.	Diameter	Recommended Volume	Cell Growth Area	Sterile	Packaging
CCD35-S	35mm	1.8-2.7 mL	8.5 cm <sup>2</sup>	Yes	10/pack 500/case
CCD60-S	60mm	4.2-6.3 mL	22.9 cm <sup>2</sup>	Yes	20/pack 500/case
CCD100-S	100mm (Grip Design)	11-16.5 mL	57.6 cm <sup>2</sup>	Yes	10/pack 300/case

# F. Finetech® Erlenmeyer Shake Flasks

## ◆ Features



- Polyethylene terephthalate glycol-modified (PETG) construction: provides excellent optical clarity and mechanical strength
- Sizes range from 125 to 1000ml
- Molded-in graduations for accuracy ( $\pm 5\%$ )
- Vent cap for continuous gas exchange while ensuring sterility and preventing leakage
- Individually packaged
- RNase-/DNase-free
- Nonpyrogenic

## ◆ Erlenmeyer Shake Flasks Ordering Information

Volume	Cap type	Model No.	Description	Min. package	Sales Package
125ml	Seal Cap	ESF-125S-PE	PETG, Irradiation sterilization	1pc/pack	24pack/case
250ml		ESF-250S-PE		1pc/pack	12pack/case
500ml		ESF-500S-PE		1pc/pack	12pack/case
1000ml		ESF-1000S-PE		1pc/pack	12pack/case
125ml	Vent Cap	ESF-125V-PE	PETG, Irradiation sterilization	1pc/pack	24pack/case
250ml		ESF-250V-PE		1pc/pack	12pack/case
500ml		ESF-500V-PE		1pc/pack	12pack/case
1000ml		ESF-1000V-PE		1pc/pack	12pack/case
125ml	Seal Cap	ESF-125S-PC	PC, Irradiation sterilization	1pc/pack	24pack/case
250ml		ESF-250S-PC		1pc/pack	12pack/case
500ml		ESF-500S-PC		1pc/pack	12pack/case
1000ml		ESF-1000S-PC		1pc/pack	12pack/case
125ml	Vent Cap	ESF-125V-PC	PC, Irradiation sterilization	1pc/pack	24pack/case
250ml		ESF-250V-PC		1pc/pack	12pack/case
500ml		ESF-500V-PC		1pc/pack	12pack/case
1000ml		ESF-1000V-PC		1pc/pack	12pack/case

# G. Finetech® Centrifuge Tubes

## 15/50ml Centrifuge Tubes



### ❖ Features

- These conical-bottom tubes are made of ultra-clear polypropylene.
- Cap Material: HDPE
- Sterility: EO or Gamma
- Leakproof
- Black printed graduations with large marking strip for easy labeling.
- Easy single-hand operation.
- Clear graduations provides easy volume reference.
- Available in non-sterile.

### ❖ Specification

	15mL	50mL
Bottom Graduation Range	0.1 ~ 1 mL	-
Bottom Graduation Interval	0.1 mL	-
Graduation Range	1.5 ~ 14.5 mL	5 ~ 50 mL
Graduation Interval	0.5 mL	2.5 mL
Freezable	-80°C	-80°C
Maximum RCF	21,800 xg	14,000 xg
Maximum RPM	15,000 rpm	12,000 rpm

## ❖ Ordering Information

Model No.	Description	Packaging
ST-tube15	15 mL centrifuge tubes, Nonsterile	25pcs/pk, 500pcs/ctn
ST-tube50	50 mL centrifuge tubes, Nonsterile	25pcs/pk, 500pcs/ctn
ST-tube15-EO	15 mL centrifuge tubes, EO sterile	25pcs/pk, 500pcs/ctn
ST-tube50-EO	50 mL centrifuge tubes, EO sterile	25pcs/pk, 500pcs/ctn
ST-tube15-GA	15 mL centrifuge tubes, Gamma sterile	25pcs/pk, 500pcs/ctn
ST-tube50-GA	50 mL centrifuge tubes, Gamma sterile	25pcs/pk, 500pcs/ctn

1



Easy to read and accurate. Black printed-on and clear-molded dual graduations (15ml) provides contrast for samples of any color.

2



Molded graduations on the conical bottom for the 15ml. Providing precise measurements of small volumes.

3

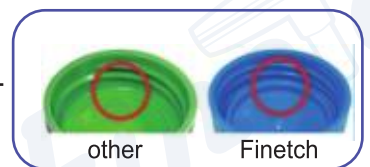

Flat caps for easy labelling and deeper plug seals for better leak resistance.

4



Large and easy-to-write-on surface for clear labeling of samples. Frosted surface (15ml) allows viewing of the sample.

5



**Caps: HDPE**  
**TUBE: PP**

- Fully recyclable and environmentally-friendly
- Made of virgin medical grade PP for the highest quality and lowest extractables.

- Rated at maximum RCF of 21,800 xg (15ml) and 14,000 xg (50ml).
- Freezable to -80C.
- DNase/RNase free and non-pyrogenic.

# H. Finetech® Pipette Filter Tips

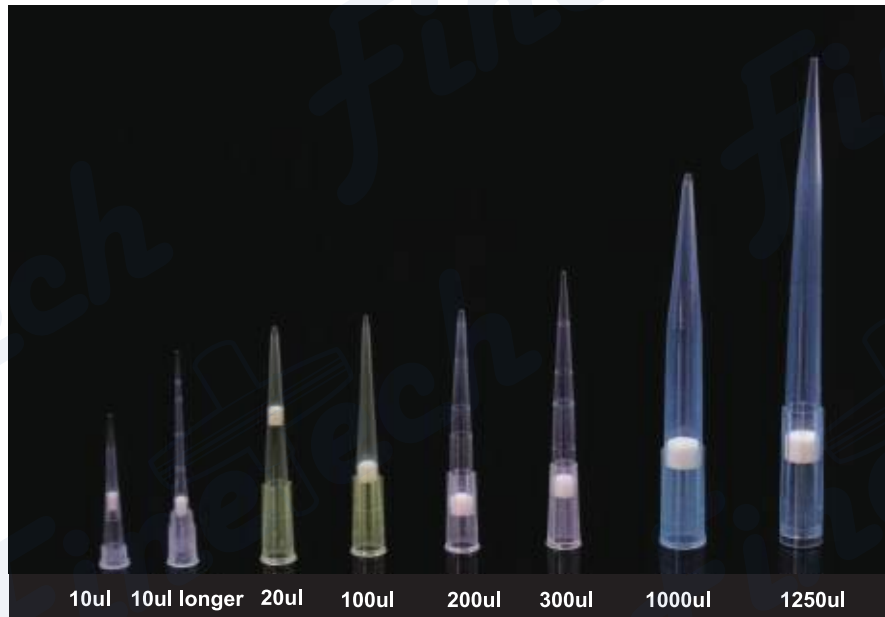

## ❖ Features

- Made of highly transparent PP material.
- Non-pyrogenic and with low adhesion.
- Compatible with Finetech, Eppendorf, Brand, Gilson, Thermo/Finn, and other brands pipette.
- High quality tip with smooth inner walls reduces sample residual.
- Racked sterile filter tips also available.
- Free of DNase, RNase, DNA, Endotoxin.

## ❖ Racked pipette tips with filter



## ❖ Ordering Information

Model No.	Description	Packaging
Tip-S10F-R	10ul Sterile filter pipette tips, Clear, Racked	96/pk,4800/cs
Tip-S10FL-R	10ul Sterile filter pipette tips, Low Retention, Clear, Racked	96/pk,4800/cs
Tip-S10FE-R	10ul Sterile Extended Long pipette tips, Clear, Racked	96/pk,4800/cs
Tip-S10FEL-R	10ul Sterile Extended Long pipette tips, Low Retention, Clear, Racked	96/pk,4800/cs
Tip-S200F-R	200ul Sterile filter pipette tips, Clear, Racked	96/pk,4800/cs
Tip-S200FL-R	200ul Sterile filter pipette tips, Low Retention, Clear, Racked,	96/pk,4800/cs
Tip-S300F-R	300ul Sterile filter pipette tips, Clear, Racked	96/pk,4800/cs
Tip-S300FL-R	300ul Sterile filter pipette tips, Low Retention, Clear, Racked,	96/pk,4800/cs
Tip-S1000F-R	1000ul Sterile filter pipette tips, blue, Racked	96/pk,4800/cs
Tip-S1000FL-R	1000ul Sterile filter pipette tips, Low Retention, Clear, Racked	96/pk,4800/cs
Tip-S1250F-R	1250ul Sterile filter pipette tips, blue, Racked	96/pk,4800/cs
Tip-S1250FL-R	1250ul Sterile filter pipette tips, Low Retention, Clear, Racked	96/pk,4800/cs

# I. Finetech® Sterile Serological Pipette

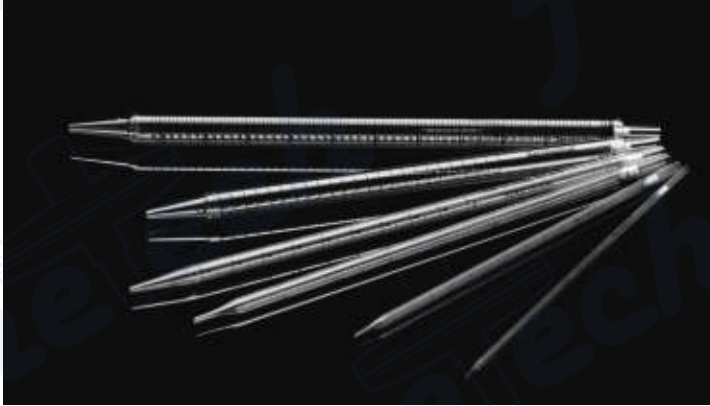

- Capacity: 1mL-50mL
- Sterilization: E-Beam
- Packaging: Individually packed

## ❖ Features

- made of imported general purpose polystyrene (GPPS) in clean room environment.
- Available in six capacity: 1.0ml, 2.0ml, 5.0ml, 10.0ml, 25.0ml, 50.0ml. Graduations are calibrated within  $\pm 2\%$ .
- 1.0ml, 2.0ml, 5.0ml pipettes are shaped by stretching method.
- 5.0ml, 10.0ml, 25.0ml, 50.0ml pipettes tips are welded to the tube by supersonic wave.
- Smooth and clean without draw lines.
- Different colors correspond to different specification, making it easy to distinguish.
- Maximum reduction of liquid adhesion to the tube inner wall, which improve the sampling accuracy.
- Excellent double-side graduation design ideally meet with the demand for liquid adding or reducing.
- Clear and simple graduation, as well as the negative one for extra volume, makes the liquid drawing and reading easier.
- All serological pipettes are assembled with high quality filters.
- Available sterile or non-sterile .
- Non-pyrogenic and DNase/RNase-free.

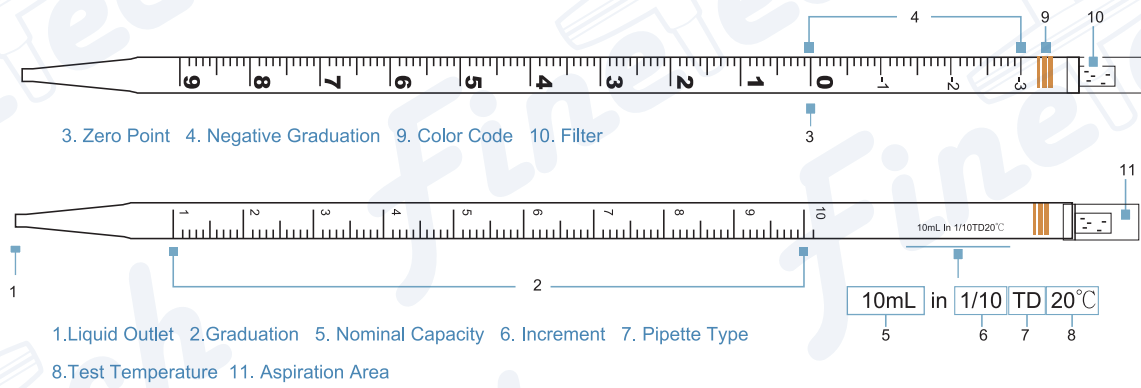

### ❖ Ordering Information

Model No.	Description	Packaging
FT9010	Capacity: 1mL Size: Ø5×270mm Individual packs and E-Beam sterilization	300pcs/box ,1800pcs/CTN
FT9020	Capacity: 2mL Size: Ø6×280mm Individual packs and E-Beam sterilization	
FT9050	Capacity: 5mL Size: Ø8×345mm Individual packs and E-Beam sterilization	200pcs/box 1200pcs/CTN
FT9100	Capacity: 10mL Size: Ø10×345mm Individual packs and E-Beam sterilization	
FT9250	Capacity: 25mL Size: Ø15×345mm Individual packs and E-Beam sterilization	100pcs/box 600pcs/CTN
FT9500	Capacity: 50mL Size: Ø18×345mm Individual packs and E-Beam sterilization	75pcs/box 450pcs/CTN



# J. Finetech<sup>®</sup> Cryotubes

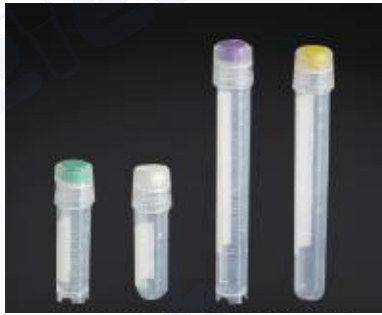

Finetech cryotubes are made of medical grade PP material and are the ideal lab consumable for biological sample storage. In the gas situation of liquid nitrogen, it can withstand temperature as low as -196°C. Silicone gel O-ring in the cap ensures no leakage, even in the standard lowest storing temperature, which will guarantee the sample's safety. Different inserted color top will help with identification. White writing area and clear graduation make the mark and volume calibration more convenient. Maximum RCF:17,000xg

- External screw cap can reduce the contamination probability during sample treatment.
- Cryotube with internal screw cap is for freezing samples in gas situation of liquid nitrogen.
- Large white writing area allows easy marking.
- Round bottom design is good for pouring liquids out with little residual.

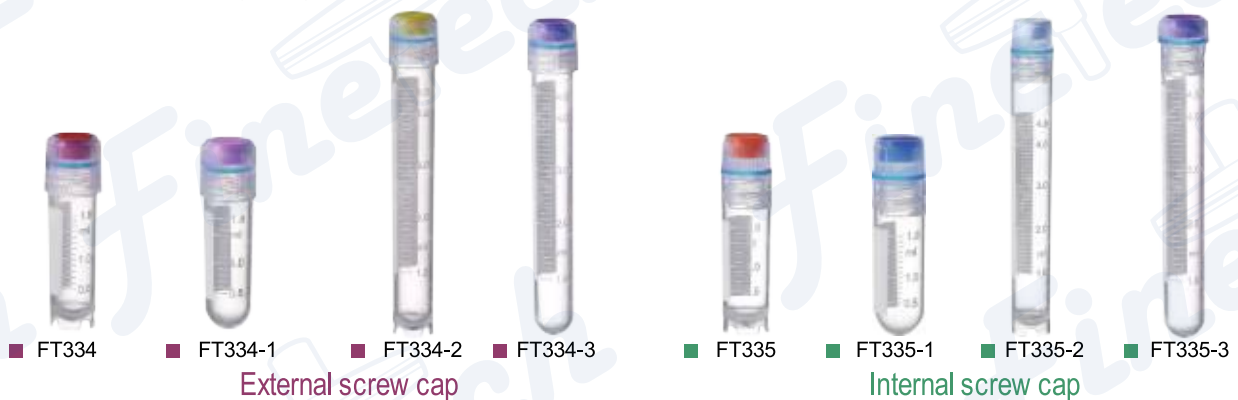

## ❖ Ordering Information

Model No.	Description	Package
FT334	Cryotube 1.8ml, external screw cap with color, self standing	500pc/bag 5000pcs/CTN
FT334-EO	Cryotube 1.8ml, external screw cap with color, self standing, Sterile	500pcs/bag 2000pcs/CTN
FT334-1	Cryotube 1.8ml, external screw cap with color code, Round Bottom	500pc/bag 5000pcs/CTN
FT334-2	Cryotube 4.5ml, external screw cap with color code, self standing	200pcs/bag 2000PCS/CTN
FT334-3	Cryotube 4.5ml, external screw cap with color code, Round Bottom	200pcs/bag 2000PCS/CTN
FT335	Cryotube 1.8ml, Internal screw cap with color, self standing	500pc/bag 5000PCS/CTN
FT335-EO	Cryotube 1.8ml, Internal screw cap with color, self standing, Sterile	100pc/bag 2000pcs/CTN
FT335-1	Cryotube 1.8ml, Internal screw cap with color code ,Round Bottom	500pc/bag 5000PCS/CTN
FT335-2	Cryotube 4.5ml, Internal screw cap with color code, self standing	200pcs/bag 2000PCS/CTN
FT335-3	Cryotube 4.5ml, Internal screw cap with color code, Round standing	200pcs/bag 2000PCS/CTN
CT-25-PC	Cryogenic PC box, 7.4*7.4*5.4cm,for 2ml cryotube of 25pcs resistant -196 °C	50pcs/CTN
CT-100-PC	Cryogenic PC(COVER)PP(BOX) , 13.2*13.2*5.3cm,for 0.5-2ml Internal screw cap of cryotube resistant temperature from 121 °C -to196 °C	50pcs/CTN

For more, please visit [www.finetech-filters.com](http://www.finetech-filters.com)

# K. Finetech<sup>®</sup> PCR Supplies

## K 1 PCR Single Tubes

Finetech<sup>®</sup> PCR tubes are easy to open and provide tight sealing to prevent evaporation. With their thin, consistent wall thickness and smooth wall surface, they also ensure efficient heat transfer to the sample, speeding up your PCR.



Unit:mm						
A	B	C	D	E	F	G
21.70	13.12	φ6.95	22.91	20.34	17.5°	8.31

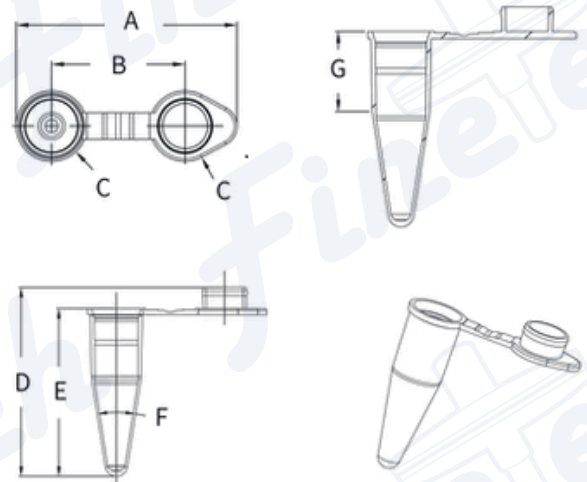

### ❖ Features

- ▶ Thin wall: allows precise thermal transfer.
- ▶ Easy labeling
- ▶ Low Evaporation: insertion cap ensures a tight fit to reduce evaporation.
- ▶ Autoclavable
- ▶ No DNase, RNase, heat source and inhibitor pollution.

### ❖ Ordering Information

Model NO.	Description	Packaging
PCR-T02	0.2ml, PCR Single Tube, Clear, Flat Cap	1000pcs/bag, 10000pcs/cn

## K 2 PCR 8-Strip Tubes



### ❖ Features

- ▶ Thin wall: allows precise thermal transfer.
- ▶ Easy labeling
- ▶ Low Evaporation: insertion cap ensures a tight fit to reduce evaporation.
- ▶ Attached caps help avoid cross-contamination between different tubes
- ▶ Autoclavable
- ▶ No DNase, RNase, heat source and inhibitor pollution.



PCR-T02-8A



PCR-T02-8AW



PCR-T01-8A



PCR-T01-8AW

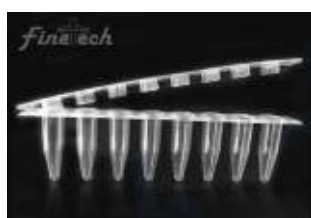

PCR-T02-8B



PCR-T01-8B



PCR-T01-8BW

❖ Ordering Information

◆ PCR 8-Strip Tubes		
Model NO.	Description	Packaging
PCR-T02-8A	0.2ml PCR 8-strip tube+Flat cap, Clear	125strips/bag, 1250strips/cn
PCR-T02-8AW	0.2ml PCR 8-strip tube+Flat Cap, White	125strips/bag, 1250strips/cn
PCR-T01-8A	0.1ml PCR 8-strip tube+Flat cap, Clear	125strips/bag, 1250strips/cn
PCR-T01-8AW	0.1ml PCR 8-strip tube+Flat cap, White	125strips/bag, 1250strips/cn
PCR-T02-8B	0.2ml PCR 8-strip tube+Flat Cap, Clear suitable for: BIOplastics	125strips/bag, 1250strips/cn
PCR-T01-8B	0.1ml PCR 8-strip tube+Flat cap, Clear suitable for: BIOplastics	125strips/bag, 1251strips/cn
PCR-T01-8BW	0.1ml PCR 8-strip tube+Flat cap, White suitable for: BIOplastics	125strips/bag, 1250strips/cn

❖ PCR 8-Strip Tubes Compatibility Table

0.2ml



BIO-RAD



CFX96 Deep Well DX



CFX96 Touch Deep Well



Chromo4™ System



iCycler iQ®, iQ™ 5 MyiQ™, and MyiQ™ 2 Systems

0.1ml



BIO-RAD



CFX Connect



CFX 96 Dx



CFX 96 Touch



Chromo4™ System



DNA Engine Opticon® 2 System



Roche



LightCycler Nano



LightCycler 96



LightCycler 480

## K 3 PCR 96 Well Plates

Finetech<sup>®</sup> 96-well PCR plates formats include semi-skirted, and unskirted; clear or white wells; colored plates. Thin and consistent wall thickness allows precise thermal transfer for optimum results.

### ❖ Features

- ▶ RNase-DNase-free
- ▶ Non-pyrogenic
- ▶ Non-sterile
- ▶ Manufactured with pure virgin polypropylene
- ▶ Suitable for 0.1ml and 0.2ml thermal cycle module.
- ▶ Application/Compatibility: Bio-Rad, ABI, Roche etc..

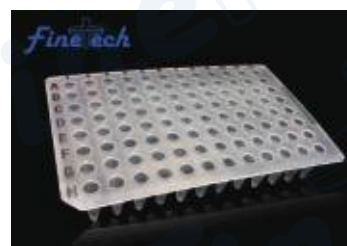

■ PCR-P02-N-B

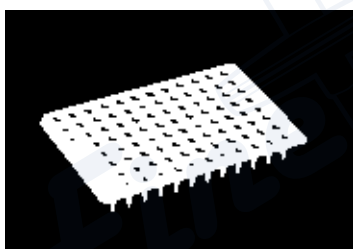

■ PCR-P01-NW

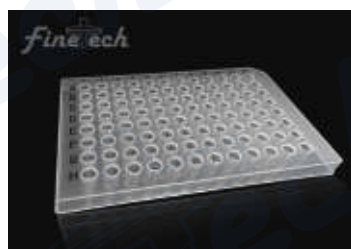

■ PCR-P02-S-P

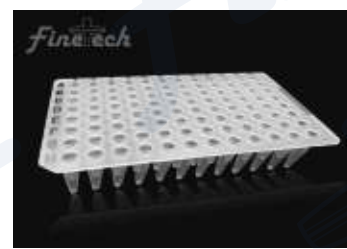

■ PCR-P02-N-P

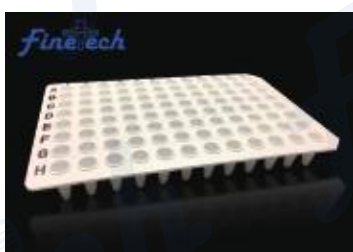

■ PCR-P01-NW-P



■ PCR-P01-N-P

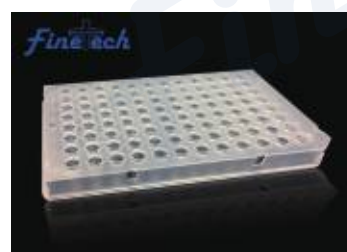

■ PCR-P01-S-R

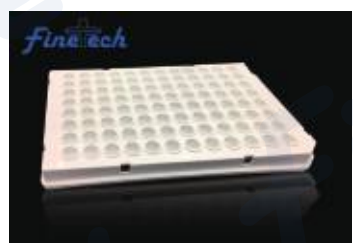

■ PCR-P01-SW-R

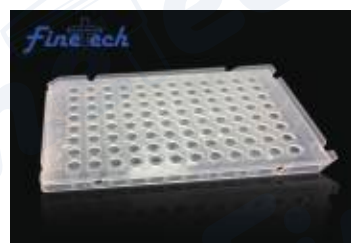

■ PCR-P01-S-A



■ PCR-P02-S-A

## ❖ Ordering Information

<b>◆ PCR 96 Well Plates</b>		
<b>Model NO.</b>	<b>Description</b>	<b>Packaging</b>
PCR-P02-S	0.2ml, 96 well PCR plate, Semi-Skirt, Clear, No printing	10pcs/bag, 50pcs/cn
PCR-P02-N	0.2ml, 96 well PCR plate, Non Skirt, Clear, No printing	10pcs/bag, 50pcs/cn
PCR-P02-NW	0.2ml, 96 well PCR plate, Non Skirt, white, No printing	10pcs/bag, 50pcs/cn
PCR-P01-N	0.1ml, 96 well PCR plate, Non Skirt, Clear, No printing	10pcs/bag, 50pcs/cn
PCR-P01-NW	0.1ml, 96 well PCR plate, Non Skirt, white, No printing	10pcs/bag, 50pcs/cn
PCR-P02-S-P	0.2ml, 96 well PCR plate, Semi-Skirt, Clear, Printing	10pcs/bag, 50pcs/cn
PCR-P02-N-P	0.2ml, 96 well PCR plate, Non Skirt, Clear, Printing	10pcs/bag, 50pcs/cn
PCR-P02-NW-P	0.2ml, 96 well PCR plate, Non Skirt, White, printing	10pcs/bag, 50pcs/cn
PCR-P01-N-P	0.1ml, 96 well PCR plate, Non Skirt, Clear, printing	10pcs/bag, 50pcs/cn
PCR-P01-NW-P	0.1ml, 96 well PCR plate, Non Skirt, white, printing	10pcs/bag, 50pcs/cn
PCR-P01-S-R	0.1ml, 96 well PCR plate, Semi-Skirt, Clear ( for Roche )	10pcs/bag, 50pcs/cn
PCR-P01-SW-R	0.1ml, 96 well PCR plate, Semi-Skirt, white ( for Roche )	10pcs/bag, 50pcs/cn
PCR-P01-S-A	0.1ml, 96 well PCR plate, Semi-Skirt, Clear (for ABI)	10pcs/bag, 50pcs/cn
PCR-P02-S-A	0.2ml, 96 well PCR plate, Semi-Skirt, Clear (for ABI)	10pcs/bag, 50pcs/cn
PCR-F	Pressure sensitive adhesive PE sealing film, -200~1200, transparent, 132*80mm(for Finetech)	100 pcs/box , with 1 pcs scratch card

# L. Finetech<sup>®</sup> Nasal Swab

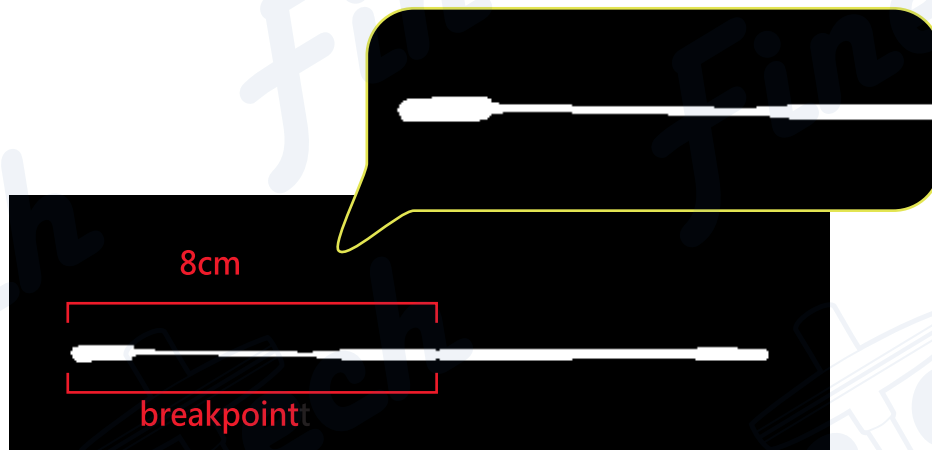

## ❖ Features

- ▶ Suitable for collection of viruses such as COVID-19 and influenza virus.
- ▶ For nasal or nasopharyngeal specimen collection.
- ▶ Oral flocked swab available.
- ▶ Soft and flexible shaft for improved sampling comfort.
- ▶ Available in sterile or non-sterile.

## ❖ Ordering Information

<b>◆ Ordering Information</b>		
<b>Model No.</b>	<b>Description</b>	<b>Packaging</b>
NSWAB-S	Sterile Nylon Flocked Nasopharyngeal Swab, w/snapping shaft.	1pc/bag 100pcs/pack
NSWAB	Non-sterile Nylon Flocked Nasopharyngeal Swab, w/snapping shaft.	100pcs/bag

# FINETECH RESEARCH & INNOVATION CORP.



website

## Company Profile

- Since 1999, Finetech Research and Innovation Corporation has been manufacturing and supplying laboratory consumables to various types of labs all over the world. With exports to over 40 countries, Finetech has become one of the leading provider for environmental, pharmaceutical, biological, and other testing laboratories
- Finetech began with the research & development and manufacturing of syringe filters and other filtration products. In keeping with our core principle of innovation, Finetech has expanded their product line to include lab equipment and other supplies to meet the needs of their customers.
- Finetech follows the principles of quality over quantity and good services for all. The importance of quality can be seen in the use of quality imported materials and equipment, the use of a cleanroom, and the strict quality control standards.



Contact us

## FINETECH RESEARCH & INNOVATION CORP

- Sample vials
- Glass fiber filters
- Biochemical supplies
- Syringe filters
- Air filters

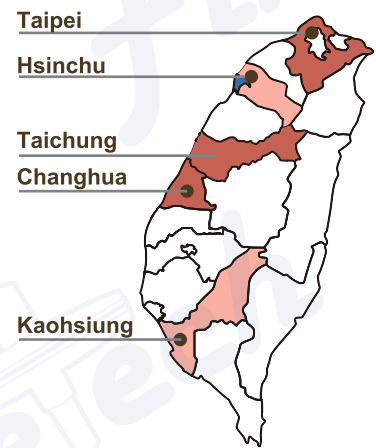

✉ [sales@finetech-filters.com](mailto:sales@finetech-filters.com) ☎ +886-977-216-648  
line/whatsapp: +886-977-216-648 (Patrick)